

Miniature One-touch Fittings

Inch-size One-touch Mini

Series KJ

Applicable Tubing : $\phi 1/8''$, $\phi 5/32''$, $\phi 1/4''$

Connection Thread : 10-32 UNF, NPT 1/16, NPT 1/8

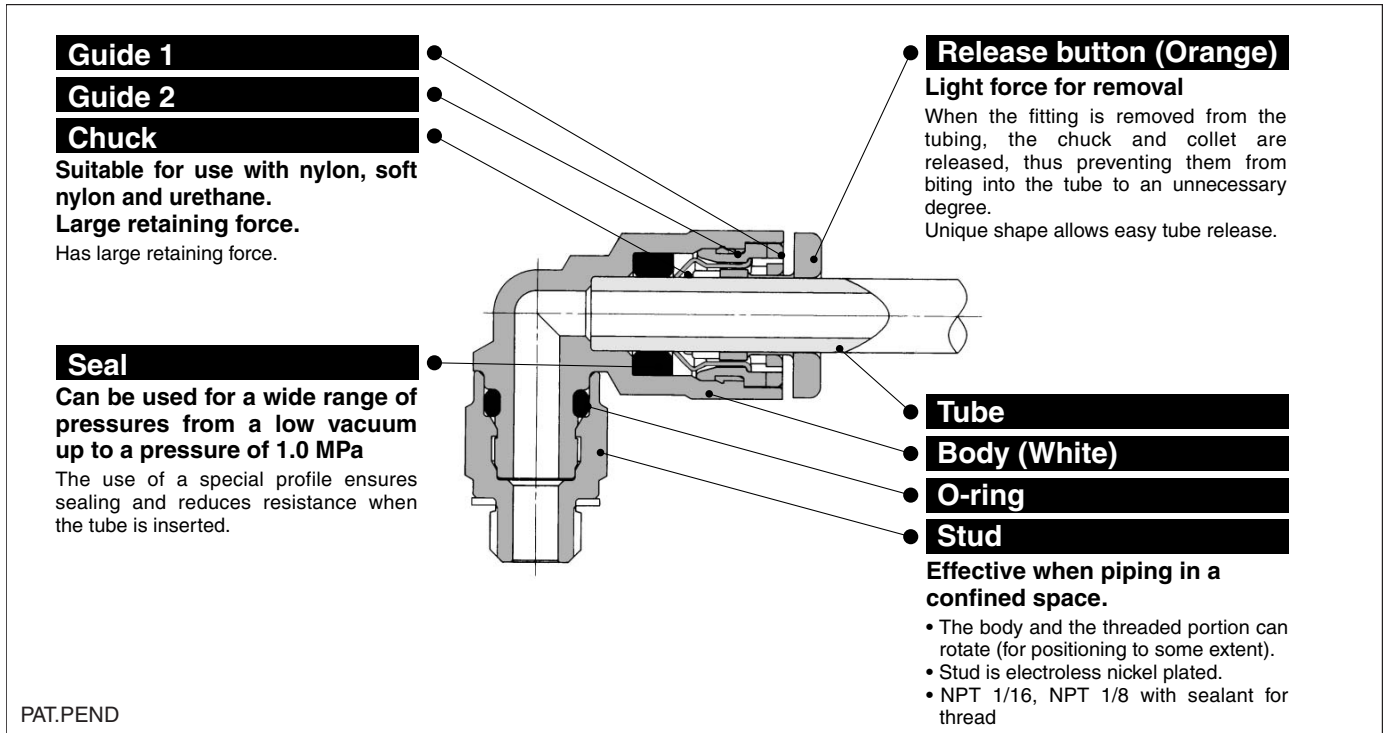

- K
- M
- H
- D
- MS
- T
- VMG

Optimum piping in less space with 20% reduction of the outside

Thread seal is standard.

Copper-free specifications (Electroless nickel plated)

Possible to use from vacuum -100 kPa



Applicable Tubing

Tubing material	Nylon, Soft nylon, Polyurethane
Tubing O.D.	$\phi 1/8$, $\phi 5/32$, $\phi 1/4$

Specifications











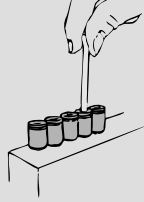

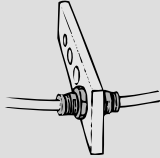
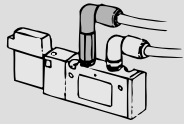







Fluid	Air/Water ^{Note)}	
Maximum operating pressure	1.0 MPa	
Operating vacuum pressure	-100 kPa	
Proof pressure	3.0 MPa	
Ambient and fluid temperature	-5 to 60°C (Water: 0 to 40°C) (No freezing)	
Thread	Mounting section	ANSI/ASME B1.20.1-1983 (NTP thread) JIS B 0212 2A, Class 2B (UNF thread)
	Nut section	JIS B 0212 2A, Class 2B (UNF thread)
Thread seal (Standard)	With thread seal	
Copper-free (Standard)	Brass parts are all electroless nickel plated.	

Note) Applicable for general industrial water. Please consult with SMC if using for other kinds of fluid.
Also, the surge pressure must be under the maximum operating pressure.

Principal Parts Material

Body	Stainless steel 303, C3604BD, PBT
Stud	C3604BD (Thread portion)
Chuck, Guide 2	Stainless steel 304
Release button, Guide 1	POM
Seal, O-ring	NBR
Gasket	Stainless steel 304, NBR

Series KJ

Model					
Hex. socket head male connector KJS P. 3 	Internal hex. allows thread connection by using an allen wrench for confined spaces. 	Bulkhead union KJE P. 8 	Use to connect tubes through a panel. 	Extended male elbow KJW P. 5 	Basically, it is used together with male elbow. Different point is that it is used for fittings to avoid from interfering with each other by making the piping two-level.
Male connector KJH P. 3 	Use to pipe in the same direction from female thread. Most general style.	Plug-in elbow KJL P. 4 	Use to change by 90° in a tube fetching direction from One-touch fittings.	Union "Y" KJU P. 7 	Use to branch line in the same direction.
Female connector KJF P. 3 	Use to pipe from male thread such as pressure gauge.	Reducer elbow KJL P. 5 	Use to change by 90° in tube fetching direction from One-touch fittings and to size down.	Different dia. union "Y" KJU P. 7 	Use to branch line with size down in the same direction.
Straight union KJH P. 3 	Use to connect tubes in the same direction.	Male branch tee KJT P. 5 	Use to branch line from female thread in both 90° directions.	Plug-in "Y" KJU P. 7 	Use to branch line in the same direction from One-touch fittings.
Different diameter straight KJH P. 4 	Use to connect different sized tubes.	Union tee KJT P. 6 	Use to connect tubes in both 90° directions.	Different diameter plug-in "Y" KJX P. 7 	Use to branch line with size down in the same direction from One-touch fittings.
Male elbow KJL P. 4 	Use to pipe at right angles to female thread. Most general styles.	Different diameter tee KJT P. 6 	Use to connect tubes with size down in both 90° directions.	Branch "Y" KJU P. 8 	Use to branch line in the same direction from female thread.
Union elbow KJL P. 4 	Use to connect tubes at right angles.	Male run tee KJY P. 6 	Use to branch line in the same direction from female thread and in 90° direction.	Plug-in reducer KJR P. 8 	Use to size down One-touch fittings.

Gasket/10-32 UNF seal on thread

Part no.: M-10/32G

Material: Stainless steel 304, NBR

⚠ Precautions

Be sure to read before handling. Refer to pages 15-18-3 to 15-18-4 for Safety Instructions and Common Precautions on the products mentioned in this catalog, and refer to pages 15-1-10 to 15-1-11 for Precautions on every series.

Interchangeability of Series KJ and KQ

⚠ Caution

- Do not use the plug-in KQ Series with the KJ Series, it will not hold.
- For combinations other than the plug-in KQs, they are interchangeable.

Installation and Removal of One-touch Mini Fittings

⚠ Caution

Installing of tube

- Cut the tube perpendicularly, using caution not to damage its surface. (Use tube cutter "TK-1", "TK-2" or "TK-3". Do not cut the tube with cutting pliers, nippers, scissors, etc.)
- Grasp the tube, then slowly push it until it comes to a stop.
- Then, pull it back gently to make sure that it does not come out.

Removing of tube

(Use one hand for removal.)

- Hold the release button with the thumb and forefinger.
- Grasp the tube with the remaining three fingers and palm.
- Then, pull out the tube with three fingers and palm while pushing in the release button with the thumb and the forefinger.
- To reuse the released tube, cut off the damaged portion of the tube.

Series KJ

Union Tee: KJT

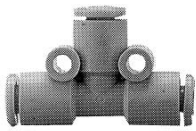

Applicable tubing O.D. (inch)	Model	Note) ϕD	L	Q	M	Min. port size	Weight (g)
1/8	KJT01-00	8.4	15	5.8	12.7	2.5	2.5
5/32	KJT03-00	9.3	15.8	6.3	12.7	3	3
1/4	KJT07-00	12	17.4	7.6	13.6	4.6	4.8

Note) ϕD : Max. diameter

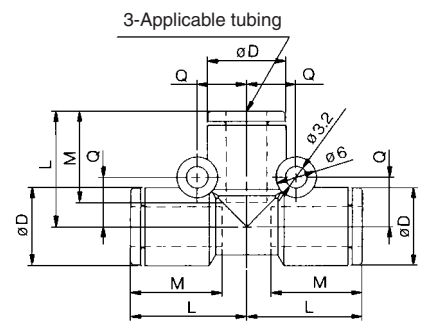

Different Diameter Tee: KJT

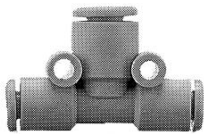

Applicable tubing O.D. (inch)		Model	Note) $\phi D1$	Note) $\phi D2$	L1	L2	Q1	Q2	M1	M2	Min. port size	Weight (g)
a	b											
1/8	5/32	KJT01-03	9.3	8.4	15.3	15.8	5.8	6.3	12.7	12.7	2.5	2.8
5/32	1/4	KJT03-07	12	9.3	16.4	16.8	6.3	7.6	13.6	12.7	2.5	3.9

Note) $\phi D1$, $\phi D2$: Max. diameter

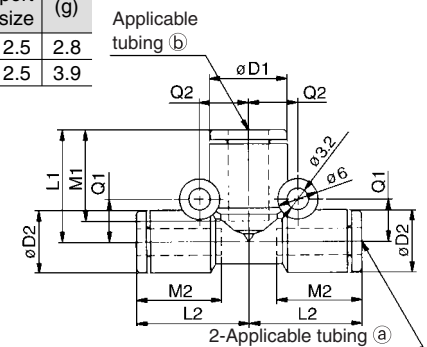

Male Run Tee: KJY

<10-32 UNF>

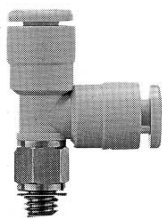

Applicable tubing O.D. (inch)	Connection thread (T) UNF NPT	Model	H (Width across flats)	Note) ϕD	L1	L2	L3	A	M	Min. port size	Weight (g)
1/8	10-32 UNF	KJY01-32	7	8.4	15.4	14.8	13.2	24.9	12.7	2.3	3.2
	1/16	KJY01-33S	9.5							2.5	5.1
	1/8	KJY01-34S	11.11							2.5	7.4
5/32	10-32 UNF	KJY03-32	7	9.3	15.6	14.8	13.7	25.4	12.7	2.3	3.5
	1/16	KJY03-33S	9.5							2.5	5.4
	1/8	KJY03-34S	11.11							2.5	7.7
1/4	10-32 UNF	KJY07-32	7	12	17.6	17.6	15.1	29.6	13.6	2.3	4.5
	1/16	KJY07-33S	9.5							2.5	6.7
	1/8	KJY07-34S	11.11							4.6	7.5

* Reference dimensions after NPT thread installation.
Note) ϕD : Max. diameter

<10-32 UNF>

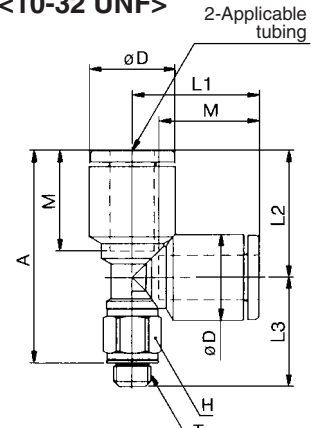

<NPT>



<NPT>

